

MITSUBISHI IGBT MODULES  
**CM200DU-34KA**

HIGH POWER SWITCHING USE

**CM200DU-34KA**



- IC .....200A
- VCES ..... 1700V
- Insulated Type
- 2-elements in a pack

**APPLICATION**

General purpose inverters & Servo controls, etc

**OUTLINE DRAWING & CIRCUIT DIAGRAM**

Dimensions in mm

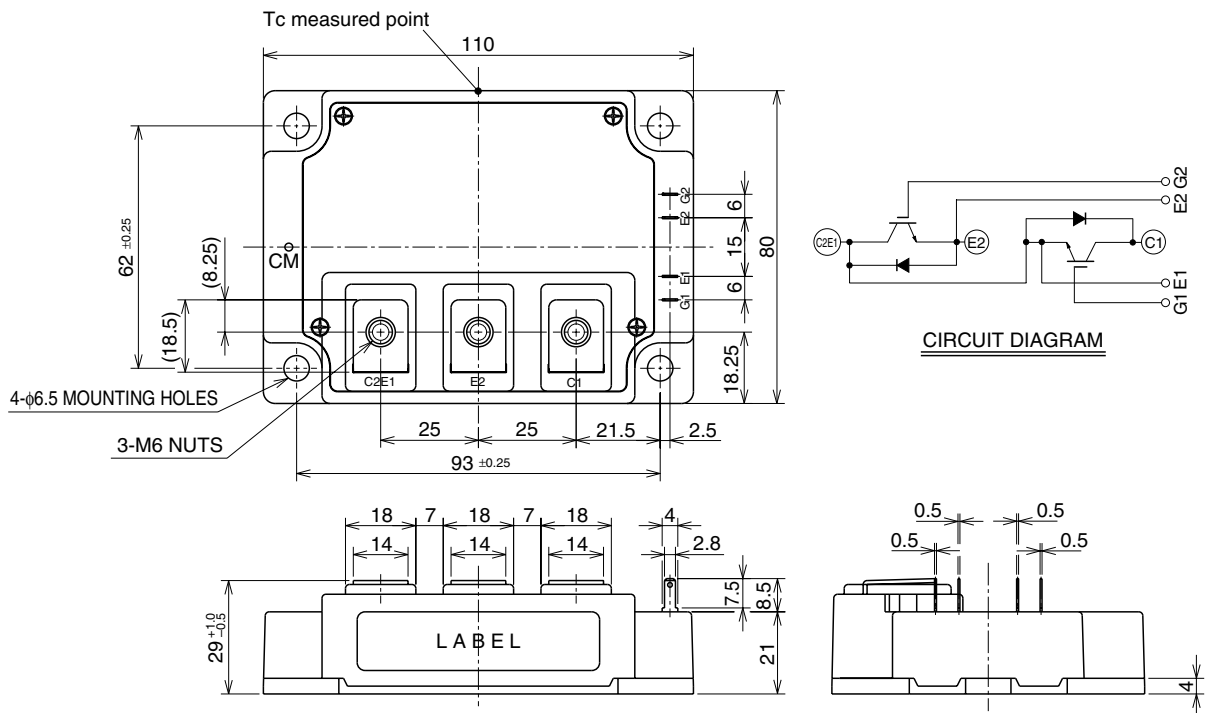

CM200DU-34KA

HIGH POWER SWITCHING USE

MAXIMUM RATINGS (Tj = 25°C)

Symbol	Parameter	Conditions	Ratings	Unit
V <sub>CE</sub> S	Collector-emitter voltage	G-E Short	1700	V
V <sub>GE</sub> S	Gate-emitter voltage	C-E Short	±20	V
I <sub>C</sub>	Collector current	T <sub>c</sub> = 25°C	200	A
I <sub>CM</sub>		Pulse (Note 2)	400	
I <sub>E</sub> (Note 1)	Emitter current	T <sub>c</sub> = 25°C	200	A
I <sub>EM</sub> (Note 1)		Pulse (Note 2)	400	
P <sub>C</sub> (Note 3)	Maximum collector dissipation	T <sub>c</sub> = 25°C	1100	W
T <sub>j</sub>	Junction temperature		-40 ~ +150	°C
T <sub>stg</sub>	Storage temperature		-40 ~ +125	°C
V <sub>iso</sub>	Isolation voltage	Main terminal to base plate, AC 1 min.	3500	V
—	Torque strength	Main Terminal M6	3.5 ~ 4.5	N • m
		Mounting holes M6	3.5 ~ 4.5	N • m
—	Weight	Typical value	580	g

ELECTRICAL CHARACTERISTICS (Tj = 25°C)

Symbol	Parameter	Test conditions	Limits			Unit
			Min.	Typ.	Max.	
I <sub>CE</sub> S	Collector cutoff current	V <sub>CE</sub> = V <sub>CE</sub> S, V <sub>GE</sub> = 0V	—	—	1	mA
V <sub>GE(th)</sub>	Gate-emitter threshold voltage	I <sub>C</sub> = 20mA, V <sub>CE</sub> = 10V	4	5.5	7	V
I <sub>GE</sub> S	Gate leakage current	V <sub>GE</sub> = V <sub>GE</sub> S, V <sub>CE</sub> = 0V	—	—	0.5	µA
V <sub>CE(sat)</sub>	Collector-emitter saturation voltage	T <sub>j</sub> = 25°C	—	3.2	4.0	V
		T <sub>j</sub> = 125°C	—	3.8	—	
C <sub>ies</sub>	Input capacitance	V <sub>CE</sub> = 10V V <sub>GE</sub> = 0V	—	—	29	nF
C <sub>oes</sub>	Output capacitance		—	—	4.8	
C <sub>res</sub>	Reverse transfer capacitance		—	—	1.5	
Q <sub>G</sub>	Total gate charge	V <sub>CC</sub> = 1000V, I <sub>C</sub> = 200A, V <sub>GE</sub> = 15V	—	900	—	nC
t <sub>d(on)</sub>	Turn-on delay time	V <sub>CC</sub> = 1000V, I <sub>C</sub> = 200A V <sub>GE1</sub> = V <sub>GE2</sub> = 15V	—	—	600	ns
t <sub>r</sub>	Turn-on rise time		—	—	200	
t <sub>d(off)</sub>	Turn-off delay time		—	—	700	
t <sub>f</sub>	Turn-off fall time		—	—	800	
t <sub>rr</sub> (Note 1)	Reverse recovery time	R <sub>G</sub> = 1.6Ω, Inductive load switching operation I <sub>E</sub> = 200A	—	—	600	ns
Q <sub>rr</sub> (Note 1)	Reverse recovery charge		—	9.6	—	µC
V <sub>EC</sub> (Note 1)	Emitter-collector voltage	I <sub>E</sub> = 200A, V <sub>GE</sub> = 0V, T <sub>j</sub> = 25°C	—	—	4.6	V
		I <sub>E</sub> = 200A, V <sub>GE</sub> = 0V, T <sub>j</sub> = 125°C	—	2.2	—	V
R <sub>th(j-c)Q</sub>	Thermal resistance*1	IGBT part (1/2 module)	—	—	0.11	°C/W
R <sub>th(j-c)R</sub>		FWDi part (1/2 module)	—	—	0.18	
R <sub>th(c-f)</sub>	Contact thermal resistance	Case to fin, Thermal compound applied*2 (1/2 module)	—	0.02	—	
R <sub>th(j-c)Q</sub>	Thermal resistance	T <sub>c</sub> measured point is just under the chips	—	—	0.05*3	

Note 1. I<sub>E</sub>, V<sub>EC</sub>, t<sub>rr</sub>, Q<sub>rr</sub>, die/dt represent characteristics of the anti-parallel, emitter to collector free-wheel diode. (FWDi).

2. Pulse width and repetition rate should be such that the device junction temp. (T<sub>j</sub>) does not exceed T<sub>jmax</sub> rating.

3. Junction temperature (T<sub>j</sub>) should not increase beyond 150°C.

4. Pulse width and repetition rate should be such as to cause negligible temperature rise.

\*1 : T<sub>c</sub> measured point is indicated in OUTLINE DRAWING.

\*2 : Typical value is measured by using Shin-etsu Silicone "G-746".

\*3 : If you use this value, R<sub>th(f-a)</sub> should be measured just under the chips.

PERFORMANCE CURVES

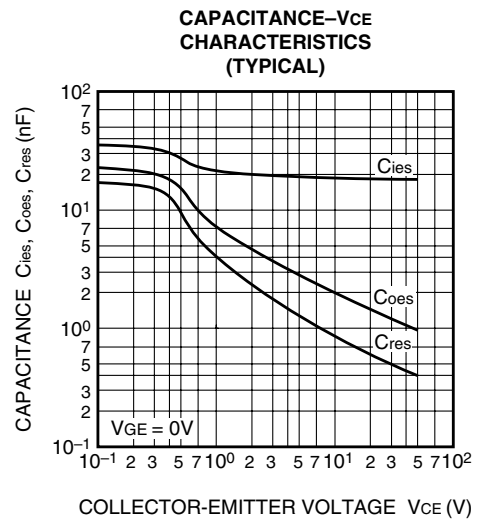
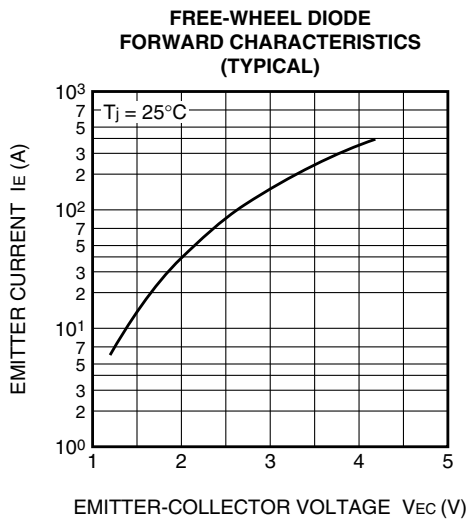
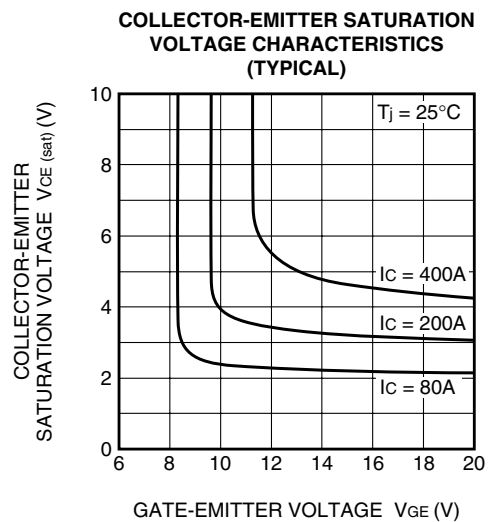
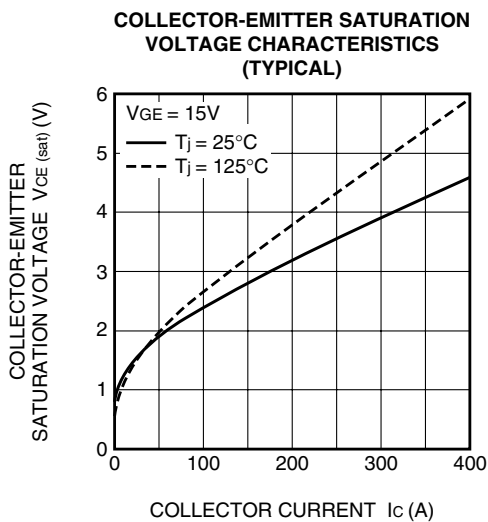
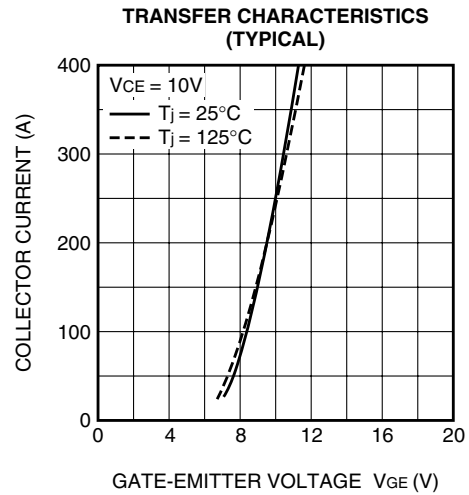
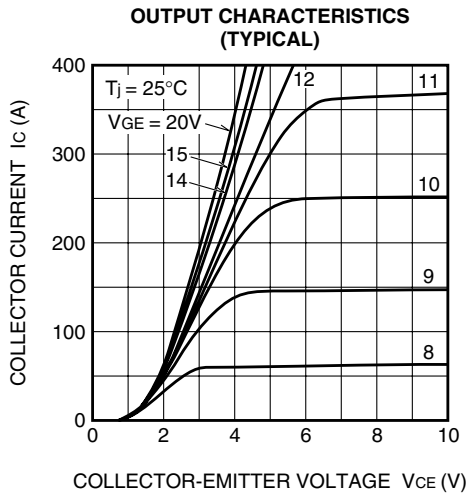

CM200DU-34KA

HIGH POWER SWITCHING USE

HALF-BRIDGE SWITCHING CHARACTERISTICS (TYPICAL)

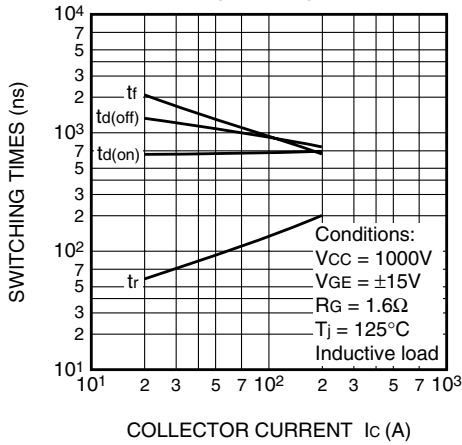

REVERSE RECOVERY CHARACTERISTICS OF FREE-WHEEL DIODE (TYPICAL)

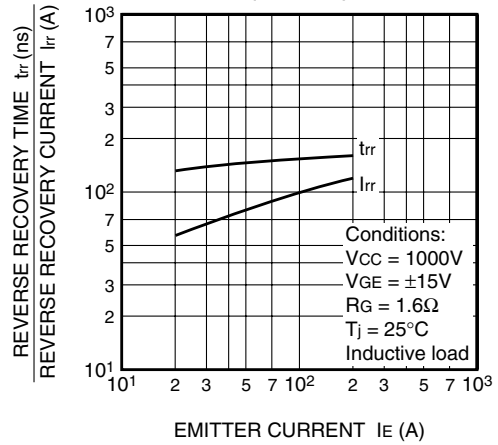

TRANSIENT THERMAL IMPEDANCE CHARACTERISTICS (IGBT part & FWDi part)

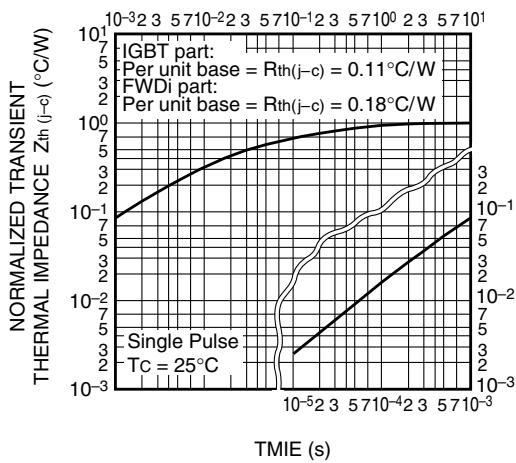

GATE CHARGE CHARACTERISTICS (TYPICAL)

